

# SUGGESTIONS

About the Use and Care of Coleman  
Quick-Lite Lanterns

1. If lantern blazes up and smokes when you light it—  
Cause—Incorrect lighting. Remedy—Read and follow directions.  
Cause—Enlarged opening in gas tip. Remedy—Put in new tip, or complete new generator.
2. If lantern doesn't light at all—  
Cause—No fuel, lack of air pressure. Remedy—See that fount contains clean fuel and then pump in 20 to 25 strokes of air.
3. If light grows dim rapidly or goes out suddenly—  
Cause—Fount may leak air. Remedy—Pump up lantern and place fount in bucket of water to test for leak. If bubbles come from Filler Plug, reseat Air Stem carefully, or get a new plug. If bubbles come from around the bushing where Valve screws into fount, remove valve. If threads on valve are not damaged, rub soap on them, replace valve, tighten it securely and retest. If leak continues, get new fount.
4. If a leak develops at lower end of Generator Q99—  
Cause—Generator not seated properly into Valve. Remedy—Close Valve Stem. Then tighten nut at bottom of Q99 with wrench. If leak continues, put on new generator. If new generator fails to stop leaking, then trouble is with Valve, which should be replaced by new one.
5. If Generator Q99 lasts only a short time—  
Cause—May be dirty gasoline. Remedy—Strain gasoline through felt or finely woven cloth when filling fount.  
Cause—Combined careless lighting would cause generator to carbonate. Remedy—Read and follow directions for lighting.
6. If mantles turn black—  
Cause—Air Intake Tube or Mixing Chamber may be stopped up. Remedy—Clean air intake or mixing chamber.  
Cause—Dirty screens in Burner Cap. Remedy—Unscrew burner caps and clean screens, or replace with new ones with wires of each screen placed diagonally with the other.  
Cause—Hole in Gas Tip may be enlarged. Remedy—Put on new tip.  
Cause—Mantles used may be of inferior quality. Remedy—Always use Coleman mantles.
7. If pump does not work—  
Cause—Plunger leather may be dry. Remedy—Remove plunger and soften leather with oil.  
Cause—Plunger leather worn out. Remedy—Put in new leather.  
Cause—Point connection lower end damaged. Remedy—Get new pump.
8. If water gets mixed with the fuel—  
Remove Filler Plug, to let out air pressure, and then remove: first the generator; next, the burner; next, the frame; and last, the valve. Shake fount moderately while contents run out. Then rinse thoroughly with clean fuel.
9. On one filling of two pints of fuel—  
The lantern will provide an average of from 10 to 12 hours' brilliant service, if directions for lighting and using are followed.

## PRICE LIST OF PARTS FOR

### Model "L327"

# Quick-Lite Lantern

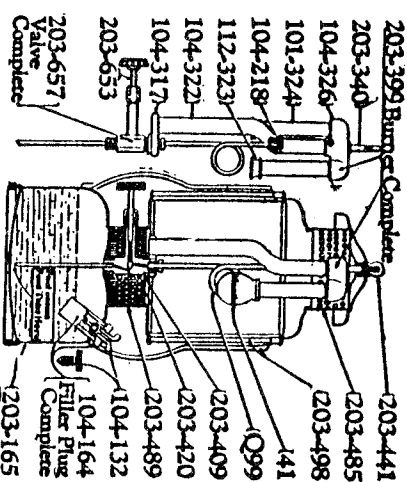

No.	Description	Net Retail Price
0	Coleman Filtering Funnel.....	\$.60
Q99	Generator (Coil Type) (104-299).....	.35
101-324	Burner Tube.....	.15
101-522	Pump.....	.75
104-218	Generator Gas Tip (Marked Q).....	.06
104-132	Filler Plug Air Stem.....	.18
104-136	Filler Plug Gasket.....	.06
104-164	Filler Plug Complete.....	.60
104-905	Gas Tip Cleaning Needle.....	.06
104-950	Wrench.....	.15
112-323	Burner Cap and Screens.....	.15
203-165	Fount Complete.....	4.50
203-399	Burner, Generator and Valve assembled.....	2.70
203-441	Ventilator Ball Nut (Small).....	.06
203-485	Ventilator (Nickel).....	1.50
203-489	Globe Base Rest.....	.15
203-498	Frame and Ball.....	.90
203-657	Fuel Valve Complete.....	.75
216-509	Pump Leather.....	2 for .09

L327 Lantern uses 2 No. 41 Coleman Junior Mantles.

Prices subject to change without notice.

Form F301E, M-10-30 MeAP

Printed in U. S. A.

# DIRECTIONS

for Assembling  
and Operating

The

## Coleman Quick-Lite LANTERN

(Model L327)

THERE are three things you must do to get satisfactory service from this lantern:

1. Always use a good grade of fresh, clean, water-white gasoline. Gasolines which have been chemically treated to remove carbon or increase power will not work well in gas pressure products as they are intended solely for use in automobile engines.
2. Be sure to thoroughly preheat generator coil before opening lantern valve. (See paragraph 4, inside.)
3. Clean out the fount of the lantern every few months. (See Par. 9, inside.)

This Direction folder is written for your convenience. Follow instructions carefully step by step.

♦ ♦ ♦ ♦

The Coleman Lamp & Stove Co.

World's Largest Manufacturers of Gasoline Appliances

Factory and General Offices: WICHITA, KANSAS  
Branches: Philadelphia, Chicago, Los Angeles  
Canadian Factory: Toronto, Canada

# Follow These Directions

(Read Down)

## 1. TO FILL—

Be sure Valve is closed tightly to right—Then remove Filler Plug and fill fount with 2 pints of clean gasoline, (also known as "petrol," "Motor Spirit," or "Essence.")

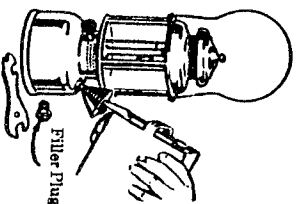

Now replace filler plug and tighten with Wrench to right.

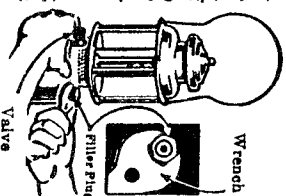

## 2. TO PUMP—

See that Valve is closed. Then loosen Air Stem on filler plug. One turn to left is enough. Now fit pump into the top of air stem and pump 25 to 30 full strokes of air into the fount. Then tighten Air Stem back to right with fingers—Do not use wrench.

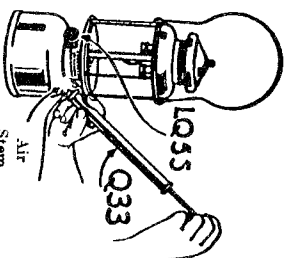

## 3. TO PUT ON MANTLES—

Unscrew ball nut on top of lantern and remove ventilator and mica chimney—Tie mantles to grooves in Burner Caps with flat side of mantles parallel to generator coil.

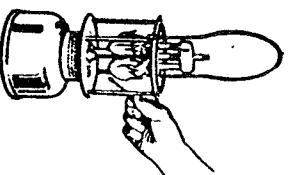

Distribute folds of mantles evenly at top and cut off surplus string.

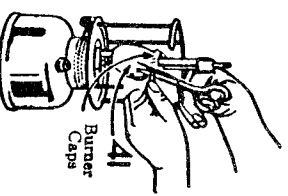

Then light mantles at bottoms with a match and allow mantles to burn until only a white ash remains—Be careful not to jolt or touch mantles while lighting lantern.

## 4. TO LIGHT—

Replace mica chimney, ventilator and ball nut—See that generator Valve is closed—Adjust mica chimney so that the door is directly in front of the generator coil—Now open chimney door and, with two lighted matches heat under side of generator coil.

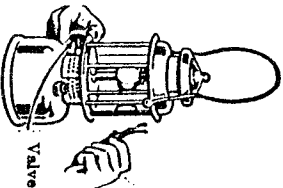

Do not open Valve until matches are burned down nearly to fingers—Then open and close valve quickly—When the mantles begin to dim, open valve one full turn to left.

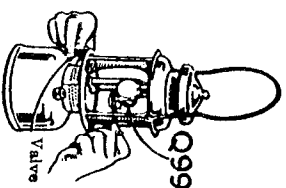

## 5. TO TURN OUT LIGHT—

Turn generator valve (black wheel) to the right till closed—the light will dim and go out in about one minute.

## 6. TO KEEP LIGHT AT FULL STRENGTH

After two or three night's use the light may begin to dim. Pump more air into fount in order to keep light burning brightly.

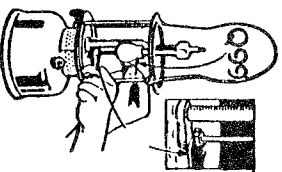

To change generators without disturbing mantles, first, remove ball nut and ventilator and take out mica chimney. Hold generator coil with finger tips or pliers, and loosen pack nut at lower end of generator with wrench.

Lift Generator up, then out, and pull it down from tube without striking mantles.

## 7. HOW TO CHANGE GENERATORS—

**Caution—When Lantern is used in Hen-houses—**to increase winter egg production the burner parts should be thoroughly cleaned occasionally (especially the burner caps and screens) to remove the dust and dirt that may collect caused by the hens scratching. A good time to do this is when changing mantles. By keeping the air mixing chamber, burner tubes, burner caps and screens clean your Quick-Lite Lantern will give more and better light and longer service.

## 8. HOW TO CLEAN GAS TIP—

Remove Gas Tip from upper end of generator, then take Cleaning Pick, and insert it through gas tip from the inside, thus removing dirt and carbon.

Do not use needles or any other wire to clean tip for fear of enlarging the orifice and hindering your light in giving its best service.

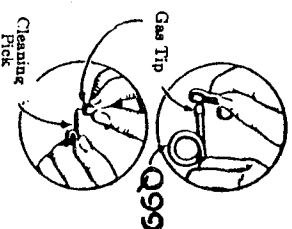

## 9. CLEAN THE FOUNT OCCASIONALLY

As long as you get satisfactory service from your lamp generators the fount is reasonably clean. However, as soon as the generator begins to clog up faster than you think it should, it is time to clean the fount. This can be done in two ways.

**First:** Siphon out all the gasoline in the fount, using a small rubber hose or tube as a siphon. Fill fount with clean gasoline and repeat siphoning process. Be sure that the end of the siphon goes clear to the bottom of the fount, for that is where the dirt and sediment is.

**Second:** Take fount to your Quick-Lite dealer. He is equipped with a special suction pump designed particularly for cleaning founts. He will clean your fount and recondition your lamp for a nominal charge. If your dealer is not able to give you this service, send your lamp to the nearest Coleman branch, where complete service will be promptly given.

**Always Use Genuine High Power  
COLEMAN MANTLES**

They are made to furnish 300 candle power of clear, pure white radiance that is always restful to the eyes.

They are made especially for Coleman Quick-Lite Lamps and Lanterns. They are just right in size, shape and texture. They are given just the right chemical treatment. They work perfectly with the gas tip and air intake in producing the splendid brilliance of the Quick-Lite.

This is why we can not guarantee either the quality or quantity of light produced by any Coleman Lamp or Lantern if an inferior low-grade mantle is used on it. So take no chances. Always insist on having Genuine Coleman Mantles.